

Redefining Patient Handling

Uniclass L7716	EPIC Q233
CI/SfB	
(66.2)	X (U35)

Ceiling Lifts





Joerns Oxford[®] Voyager[®]

The Voyager 420 will satisfy the majority of manual handling requirements with a maximum user weight of 190kg (30st/420lbs). Available as a 2-way (powered vertically, freewheel horizontally) or 4-way model (powered vertically and horizontally), the Voyager remains one of the most trusted overhead systems available.

Key features

Simple Track Design

Can be installed quickly and efficiently by one person.
A full range of track options and accessories are available.

Standard and Quick Speed Traverse

Saves time repositioning between transfers.

2 or 4-way Models

Powered vertically and horizontally or just vertically.

Low Battery Indicator

Audible and visual alert ensures there is always power when required.

Emergency Lower and Emergency Stop

Operated by a simple pull of a cord.

Simple Handset

Easy to use handset which includes a return to charge function.

Soft Start and Stop

Ensures a comfortable, safe transfer for the patient.

Oxford Spreader Bar

Allows full compatibility with Oxford's extensive range of loop slings.

Extensive room coverage



The Voyager system enables easy transfer between rooms throughout a building and can be arranged in various track layouts to suit individual requirements.

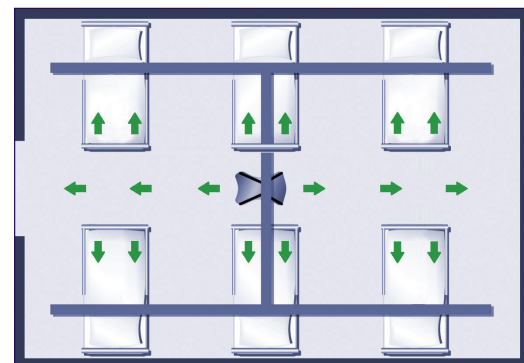

The Voyager x-y system allows complete room coverage and is perfect for multi-bed environments, such as hospital wards.

Track components and accessories

A wide range of track options are available from 2 to 6m straight track, 45° or 90° bends, x-y systems, turntables and a variety of wall and ceiling brackets to suit whichever track layout is required. This includes the following components:

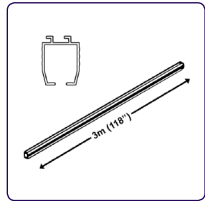

76mm Track

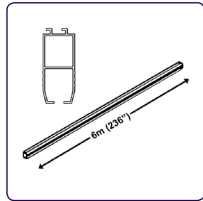

144mm Track

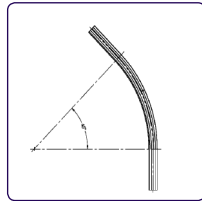

45° Curved Track

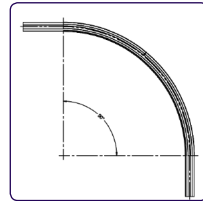

90° Curved Track

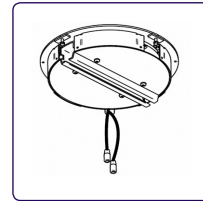

Turntable

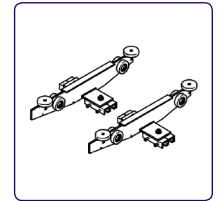

X-Y Trolley Kit

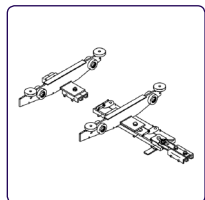

X-Y and Gate System

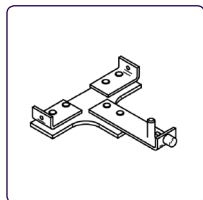

Track Junction

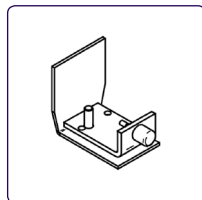

Rail Stopper

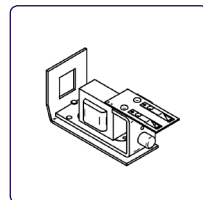

Charger Stopper

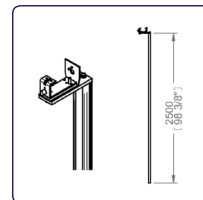

Wall Post

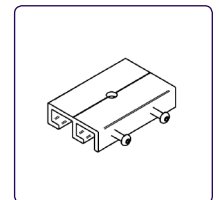

Standard Track Bracket

Dimensions

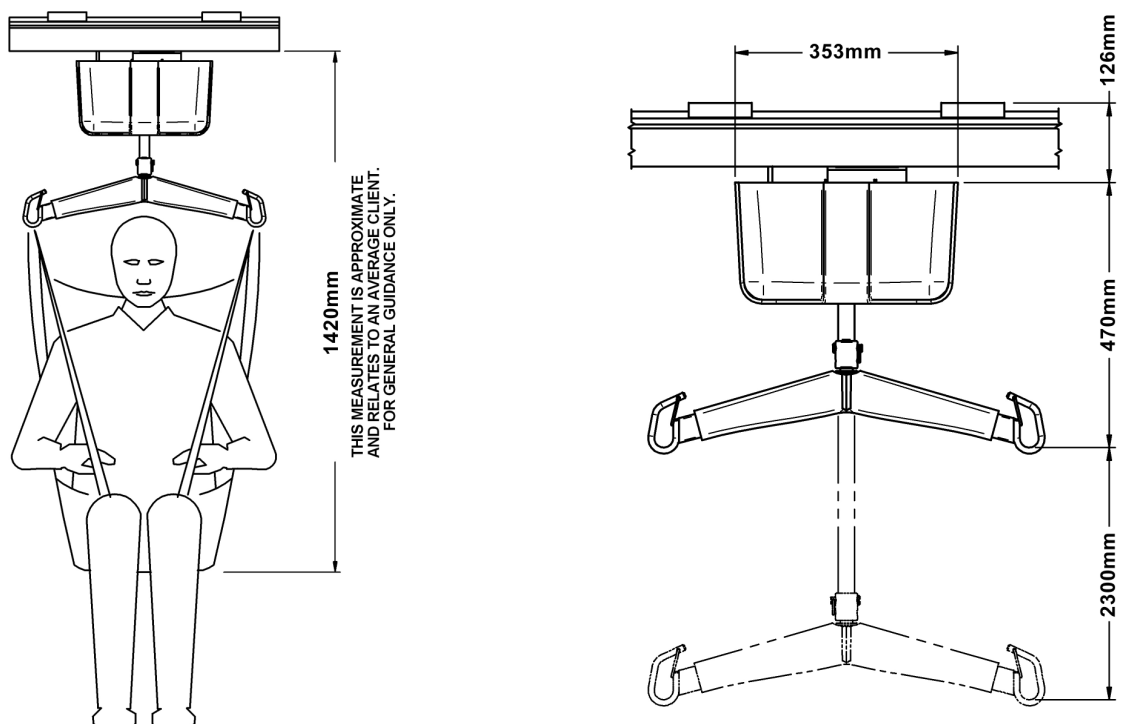

Joerns Oxford® Voyager® Portable

The Voyager Portable hoist, Easytrack and Easytrack FS systems combine to form a unique portable overhead lifting solution for the home, care home and hospital environment. Whether it's for homecare, an emergency or temporary solution, or just that a fixed ceiling lifter is not suitable, the Voyager Portable provides the perfect answer.

Key features

High Lift Capacity at 200kg SWL (441lbs/31st).

Lightweight Design enables the carer to transfer the Voyager Portable hoist easily from one room to another.

Soft Start and Stop ensures the patient is transferred safely and comfortably.

Dual Controls coupled with a removable handset allow total flexibility.

Simple Trolley allows the Voyager Portable to be used with either the Easytrack or the standard Voyager ceiling track.

Unique Quick Release Strap allows instant repositioning of the hoist, saving time and battery power. Prevents ever having to lift the hoist onto the rail.

Emergency Stop/Lower and strap twist prevention helps ensure safety never becomes an issue.

The Removable, Chargeable Battery allows 24hr use and ensures the hoist is never out of action.

Audible Low Battery Indicator will help ensure the battery will not run-out at a critical moment.



The Easytrack system is a unique overhead portable track designed for the Voyager Portable hoist. It requires no permanent fixings, no structural alterations and can be assembled in as little as 5 minutes by just one person.

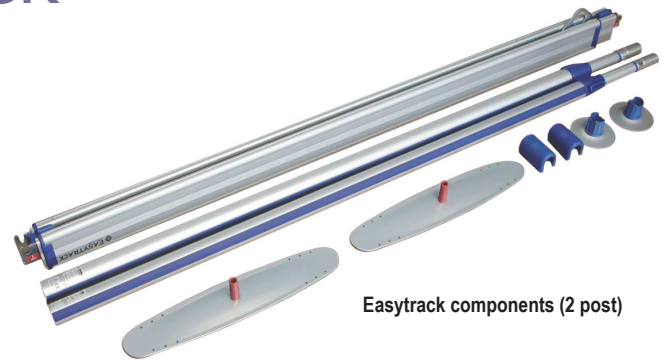

Easytrack components (2 post)

Key features

Simple Installation: The unique floor-to-ceiling design eliminates the need for specialist fixings, alterations or electrical installations. This allows the system to be used permanently, semi-permanently or even temporarily. The Easytrack is the ideal solution when a fixed ceiling track cannot be installed.

Multi-Post Options: The 2, 3 or 4 post options allows the Easytrack to solve patient handling problems in nearly every room layout. The 2 post is ideal for a simple lift in or out of a bed, the 3 post for access in two directions and the 4 post for complete coverage.

Portable Kit: The lightweight aluminium Easytrack comes in a portable kit form that can be easily transported along with the Voyager Portable hoist. A useful carry bag is available for both the Easytrack and Voyager Portable.

Footprint: The small feet of the Easytrack allows use even in the smallest bedroom or bathroom where a conventional floor lifter could not be manoeuvred.

Easy-Glide Rail: The unique design of the telescopic rail ensures that nearly any patient can be transferred without strain or risk of back injury.

Rotating Rail Connection: This allows the rail or post to be positioned at any angle, no matter how close to a wall or obstruction.

Extending Rail: Unlike regular gantry tracks the Easytrack can be extended to suit different locations as and when they are required. The track can be extended when in position to allow adjustment and then reduced to enable easier storage or transportation.

Telescopic Post: Allows the Easytrack to be used with a variety of ceiling heights.

Safety Systems: A multitude of unique safety systems have been incorporated into the Easytrack to ensure peace of mind. These systems include preventing the post losing grip if the floor or ceiling flexes, preventing the post being lowered if the rail is still connected or the rail disconnecting from the post.

Easy to Assemble



Extend posts and rotate to lock in place.



Fix one end of rail onto the post.



Extend rail to required length and fix rail onto second post.



Fix end cap to lock rail in place.

Easytrack® configurations

There are many variations of the Easytrack system with 2, 3 or 4 post configurations, thereby providing a solution for almost any setting.

2 post system:

The standard 2 post Easytrack is suited for transfer over a bed or bath in a peninsular setting:



The 2 post Easytrack.



The 2 post Easytrack with wall bracket.



The 2 post Easytrack with bath bracket.



The 2 post Easytrack without posts.

3 post system:

The 3 post Easytrack is suited for transfer over a bed or bath and down a room. This system negates the need for a traditional curved track:

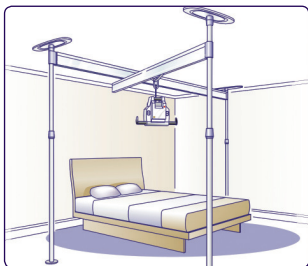

The 3 post Easytrack.

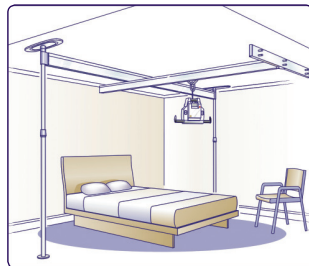

The 3 post Easytrack with wall bracket.



The 3 post Easytrack with bath bracket.

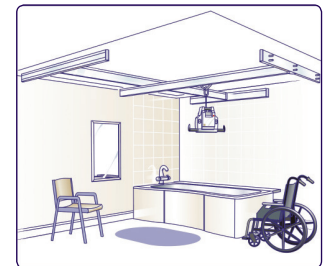

The 3 post Easytrack without posts.

4 post system:



The 4 post Easytrack operates like a traditional x-y system covering all 4 corners of a room. The 4 post is not telescopic.

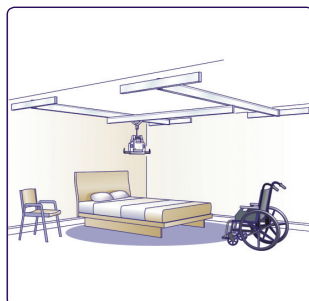

An x-y system without posts and with 4 wall brackets.



Joerns Oxford® EasytrackFS™

The Easytrack FS is a lightweight, free-standing portable overhead track system, based on many of the same principles as the current Easytrack range. Unlike the existing Easytrack system, the Easytrack FS does not rely on support from the ceiling thereby removing any potential structural issues that may be encountered.

Easy to assemble

The Easytrack FS is designed to be assembled by a single person in a matter of minutes:

- 1 Line up each post with the footplate.
- 2 Insert post into footplate. The posts are self locating and therefore require no additional tools or fixings.
- 3 Position the track into the fixing clips at the top of each post.
- 4 Lock the track in place using the ski-boot clips as shown.
- 5 Adopt a comfortable position and push upwards to adjust the height of the track as required.
- 6 Finally, attach the Voyager Portable unit and your system is ready for use.



Easytrack FS components

Key features

Maximum User Weight Limit:
200kg (441lbs/31st).

Lightweight Components:
Ensures ease of storage and transportation.

Self Locating Posts:
The posts are self locating and require no additional tools or fixings.

Telescopic Adjustment:
The Voyager FS incorporates telescopic post and track adjustment for ease of use.

Spring Loaded Posts:
To aid set-up, the posts are spring loaded so that the height can be adjusted effortlessly.

Auto Locking Mechanism:
The posts automatically lock into place once adjustment has been made.

Carry Bags and the Easykart™
Optional accessories to aid both transportation and storage.

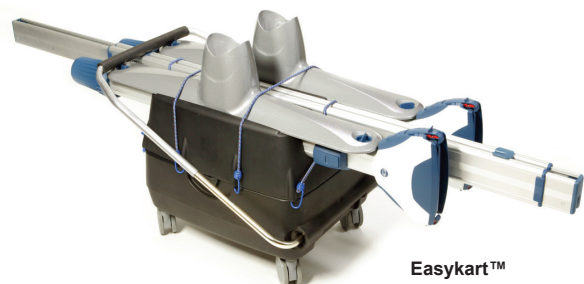

Easykart™

Technical Specifications

Specification	Voyager 420
Safe Working Load	190kg / 420lbs / 30st
Soft Start and Stop	✓
Emergency Lower	Manual / Electric
Emergency Stop	✓
Low Battery Indicator	Visual / Audible
Battery Capacity (load of 75kg)	Upto 150 transfers
Battery Charger	Integrated
Weight (including battery)	12.7kg / 28lbs
Compatible with Full Oxford Sling Range	✓
Vertical Speed	4cm / sec
Horizontal Speed	15cm / sec
Strap Length	Upto 2.2m

Specification	Voyager Portable
Safe Working Load	200kg / 441lbs / 31st
Soft Start and Stop	✓
Emergency Lower	Manual
Emergency Stop	✓
Low Battery Indicator	Audible
Battery Capacity (load of 75kg)	Upto 30 transfers
Battery Charger	Freestanding
Weight (including battery)	5.5kg / 12lbs
Quick Release Tape Mechanism	✓
Compatible with Full Oxford Sling Range	✓
Vertical Speed	4cm/sec

Specification	Easytrack 2 Post	Easytrack 3 Post	Easytrack 4 Post
Safe Working Load	200kg / 441lbs / 31st	200kg / 441lbs / 31st	200kg / 441lbs / 31st
Ceiling Height Range	2,130 - 2,745mm (84 - 108")	2,130 - 2,745mm (84 - 108")	2,130 - 2,745mm (84 - 108")
Rail Length Range	1,900 - 3,160mm (74 - 124.5")	1,900 - 3,160mm (74 - 124.5")	3,000mm (118")
Rail Weight (each)	12kg (26lbs)	12kg (26lbs)	9kg (20lbs)
Post Weight (each)	4kg (9lbs)	4kg (9lbs)	4kg (9lbs)
Total Weight	20kg (44lbs)	42.5kg (94lbs)	57kg (125lbs)
Standard Kit	✓	✓	✓
Wall Bracket Option	✓	✓	-
Bath Bracket Option	✓	✓	-
Multi-Wall Bracket Option	✓	✓	✓

Specification	Easytrack FS
Safe Working Load	200kg / 441lbs / 31st
Floor to Top of Rail	1,830 - 2,406mm (72 - 95")
Floor to Bottom of Rail	1,680 - 2,256mm (66 - 89")
Exterior Width	2,210 - 3,230mm (87 - 127")
Interior Width	1,910 - 2,930mm (75 - 115")
Footplate Length	1,075mm (42")
Footplate Width	150mm (6")
Rail Weight	14kg (31lbs)
Post Weight (each)	9.5kg (21lbs)
Footplate	5.5kg (12lbs)

Specifications may vary due to manufacturing tolerances

Electrical Specifications

Battery 1 x 24 volt rechargeable sealed lead acid type

Battery capacity 2.9 Ampere hours

Charger rated input 100 - 240 V AC / 50 / 60 Hz

Charger rated output 29.5 V DC Max 19W / IPX5

Electrical Shock Protection

Charger - class II

Lift - internal power source

Degree of shock protection

Charger - Type B

Lift - Type B

Intended operating environment

>+5° <+40°

Outside this environment, functionality and safety may be compromised

Warranty

The Voyager system comes with a 12 month warranty as standard. Please refer to the user manual for further information.



Scan me!

