



Contents

- 1.- Important
- 2.- Icons used on the label and in the manual
- 3.- Product use
- 4.- Product description
- 5.- Warnings and safety
- 6.- Assembly and use
- 7.- Technical Specifications
- 8.- Care and maintenance
- 9.- Recycling the product
- 10.- Storing the product
- 11.- Useful life
- 12.- Warranty and after-sales service
- 13.- Tests and trials carried out
- 14.- Manufacturer details











1.- Important

Read the manual carefully before using this product and keep it in case of need.

If you cannot read or understand any warning, caution or instruction, contact the seller before using the product or you may be at risk of harm.

Consult your physician or orthopaedic specialist before use. They will advise you as to the most appropriate walking technique for you.

2.- Icons used on the label and in the manual

	Manufacturer details		Date of manufacture
	Medical Device		Observe safety instructions
	Maximum user weight in kg		Declaration of Conformity
	Caution, danger of entrapment		Check the user manual
	Product recycling information		Recycling centre
SN	Product serial number	LOT	Product batch number
REF	Product reference or code		

3.- Product use

Walkers are aids to help people with walking difficulties and assist them to support themselves and keep their balance while walking.

4.- Product description



1. Rubber grip
2. Adjustable grip tube
3. Height adjustment clip
4. Seat
5. Backrest
6. Front wheels
7. Rear wheels
8. Platen
9. Brake levers
10. Basket

5.- Warnings and safety



Failure to follow these safety precautions may result in serious injury.

- Do not exceed the maximum weight limit of 130 kg.
- If the walker has a basket, do not exceed its maximum weight capacity (3 kg). Loads can only be carried in the basket. Do not place heavy objects on the walker. It might make it unstable.
- Make sure all parts are securely fastened and in good working order before using the walker.
- Make sure the walker is completely open and the seat is securely fastened before use.
- Before starting to walk, make sure that the brake lever is disengaged and is not braking the wheels.
- Test the brake lever before using the walker. When the wheels are locked, the rear wheel brake shoe should prevent the wheels from turning.
- Check that when the brake levers are released the wheels can turn freely.
- Always lock the brake levers before sitting down.
- Make sure that the two grips are fixed by the adjustment clip and are both at the same height. Check that the walker is stable before putting your full weight on the handles.
- Do not use the seat when the walker is on sloping or uneven ground. Only use the walker on flat, solid surfaces.
- Replace the wheels and ferules if they are badly worn or damaged.

- Do not move the walker while you or another person is sitting on it. This product is a walking aid and should not be used for transporting anything.
- Do not use the walker on stairs or escalators.
- Use only original Forta brand accessories and parts.
- Do not use the walker to walk backwards, in the opposite direction to the direction you are facing.
- Do not make any adjustment or change to the walker while it is in use.
- All wheels and ferrules must be in contact with the ground at all times.
- Do not use the walker to mount curbs or sidewalks.
- Do not use the product on wet, icy or snowy inclines.
- If any part is damaged, broken or worn, contact your distributor for a replacement.

6.- Assembly and use

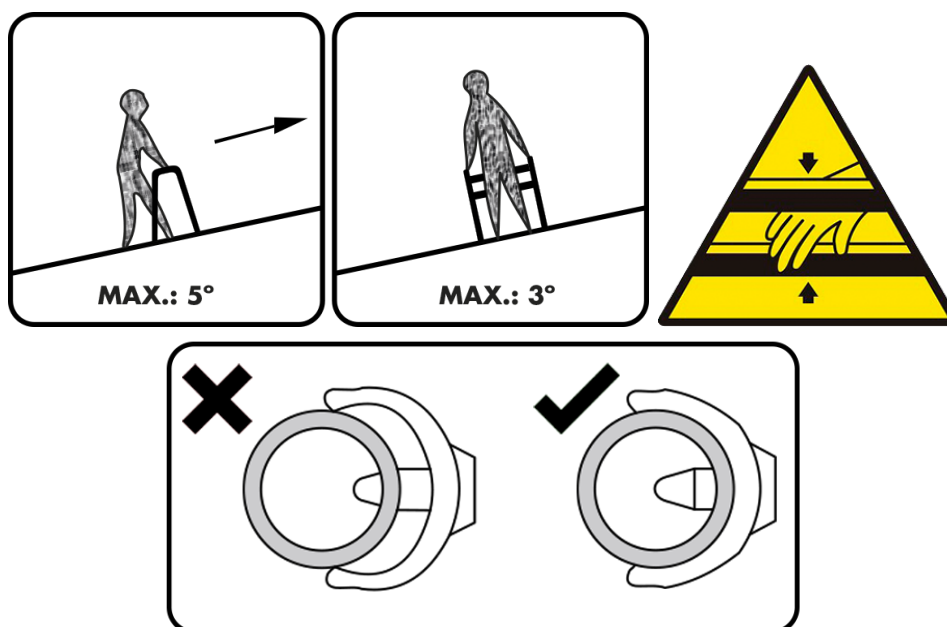

To unfold the walker, follow the instructions below:

1. Lean the walker on its rear legs and push the grips forward until they stop.
2. Lower the seat and fit it into the support tube.
3. Adjust the height of the grips and use the clip to lock them in place.

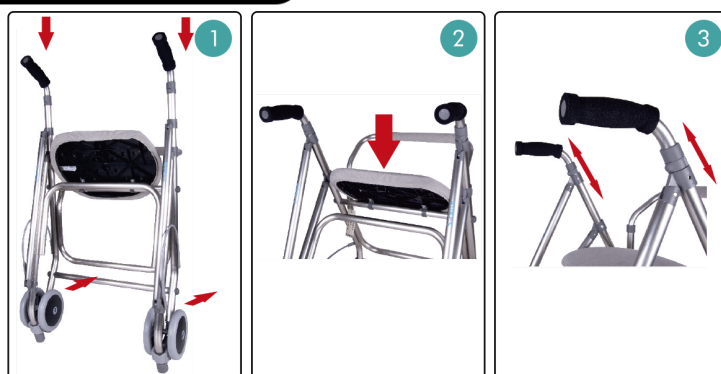

To fold the walker, follow the instructions below:

1. Pull the seat out of the support tube by pulling it upwards.
2. Lean the walker on its rear legs and pull the grips until folded.



Insert the backrest into the tubes until it stops. Make sure that the backrest is positioned on the outside so that the seat can be used and securely fastened.



The brakes have two positions

1. Unlocked: To activate the brakes, pull the brake lever towards the grip.
2. Locked: Lock the brakes by pushing the brake lever down. The brakes will remain activated, stopping the walker from moving until they are released by pulling the lever towards the grip.



7.- Technical Specifications

Dimensions, load-bearing capacity and weights are listed below:

HEIGHT	LENGTH	WIDTH	FOLDED LENGTH
850 a 960mm	645mm	570mm	300mm
SEAT MEASUREMENTS	HEIGHT TO SEAT		WHEELS DIAMETER
400x260mm	550mm		150mm
INSIDE WIDTH	WEIGHT		MAXIMUM LOAD
425mm	5,220kg		130kg

8.- Care and maintenance



Failure to care for and maintain the product in perfect condition may lead to the risk of an accident.

- Clean the product regularly with warm water and a soft cloth. Do not use abrasives, detergents or solvents.
- Wipe dry with a clean, soft, dry cloth.
- Make sure there is no build-up of dirt or hair around the axle or wheels.
- Do not use cleaning agents containing phenol or chlorine, which might damage the materials.
- If the wheels squeak, lubricate them with a little oil.
- In the event of a fault, do not repair the walker yourself. Consult an authorised distributor.

9.- Recycling the product

When the product has become unusable and requires disposal, contact your specialist dealer.



If you want to recycle it yourself, ask your local waste management company or nearest recycling centre for advice on disposal.



10.- Storing the product



If not correctly stored, the product may be damaged leading to the risk of an accident.

- Do not store this product for an extended period of time near a heat source or in the sun (e.g. in front of a window or near a radiator) or near a cold source.
- Keep the product away from flames and sparks.
- Store the product as follows:
 - Store the product in a dry, cool place.
 - Protect the product from dust and rust by packaging or bagging it.
 - Store all removed parts or components together in one place so they do not get mixed up with anything else or get lost.
 - Do not place any weight on any components (do not place heavy objects on the product or on any component).

11.- Useful life

The expected useful life of the product is 3 years in normal conditions of use, safety and maintenance. After that time, the product can be used as long while it remains in perfect conditions of use and maintenance. Some parts or components may in any event have to be replaced due to normal wear and tear within less than this time.

12.- Warranty and after-sales service

Warranty terms and conditions:

Only original Forta products purchased from authorised dealers are covered by the warranty against defects in parts and workmanship.

The warranty runs from the date of purchase for 3 years for structure and components subject to the following conditions:

- Only original FORTA products purchased from authorised dealers will be covered by the warranty against defects in parts and workmanship.
- The purchasing establishment must give notice of any defect in the product immediately.
- The manufacturer will not have any liability for defects caused by improper handling, negligence or failure to follow the instructions set out in this manual.

- During the warranty period, any part that proves defective due to faulty assembly or materials will be repaired or replaced free of charge by Forta.
- The warranty will be absolutely void if incorrect modifications or adjustments are made to the product or if parts or options not supplied for the product model are fitted.
- Damage from rust caused by misuse or negligence or the action of any liquid or gas that may damage the product are excluded from the warranty.

THE WARRANTY DOES NOT COVER THE CONSEQUENCES OF ANY TRAVEL PROBLEM, IN PARTICULAR ISSUES RELATING TO TRANSPORT, LOSS OF PROFIT, EXPENSES, ETC.

Forta will have NO liability in the following circumstances:

- Normal wear and tear of the product or inappropriate or incorrect use.
- Defects in any assembly or repair carried out by the purchaser or a third party.
- Negligent handling or maintenance or use of unsuitable parts.
- Repairs or modifications carried out in non-official workshops.
- Forta will have no liability for any harm or loss suffered by the user or any third party as a result of any modification to or alteration of any product.
- The warranty also excludes modifications made other than with original Forta parts.

The warranty certificate must be sent to FORTA, S.L. together with a photocopy of the purchase invoice within 15 days from the date of purchase. To validate the warranty, the user must submit the warranty certificate bearing the stamp the seal of the outlet that sold the product. You can download the warranty certificate here: [www.fortasl.es/en/manuales/doc/GARANTIA CONTRACTUAL.pdf](http://www.fortasl.es/en/manuales/doc/GARANTIA_CONTRACTUAL.pdf).

13.- Tests and trials carried out

FORTA products comply with Annex IV to MDR (EU) 2017/745, are CE marked and have been designed and tested in accordance with UNE-EN ISO 11199-2:2021. Forta is obliged to certify compliance by its products with a number of essential requirements. There is a standard that specifies the inspection and testing methods to show compliance of the products with those requirements. The standards that the product complies with are listed below:

Brief description of relevant law	Current law
Information provided by the manufacturer	UNE-EN 1041:2009+A1:2014
Quality management system	UNE-EN ISO 13485:2018
Risk management	UNE-EN ISO 14971:2020
Testing of medical devices and walkers	UNE-EN 12182:2012 UNE-EN 11199-2:2021
Biological assessment of medical devices	UNE-EN ISO 10993-1:2021
Maximum load	130 kg

14.- Manufacturer details

FORTA - FABRICACIONES ORTOPÉDICAS ALBACETE, S.L.

Pq. Emp. Campollano, c/C 90 Nave 1

02007 Albacete

España - Spain

info@fortasl.es

www.fortasl.es



MADE IN EUROPE

